

Varenummer: 20187012  
 Beskrivelse: E+G  
 Positioneringsbolt GN 717-4-M6-B-ST

## Mål

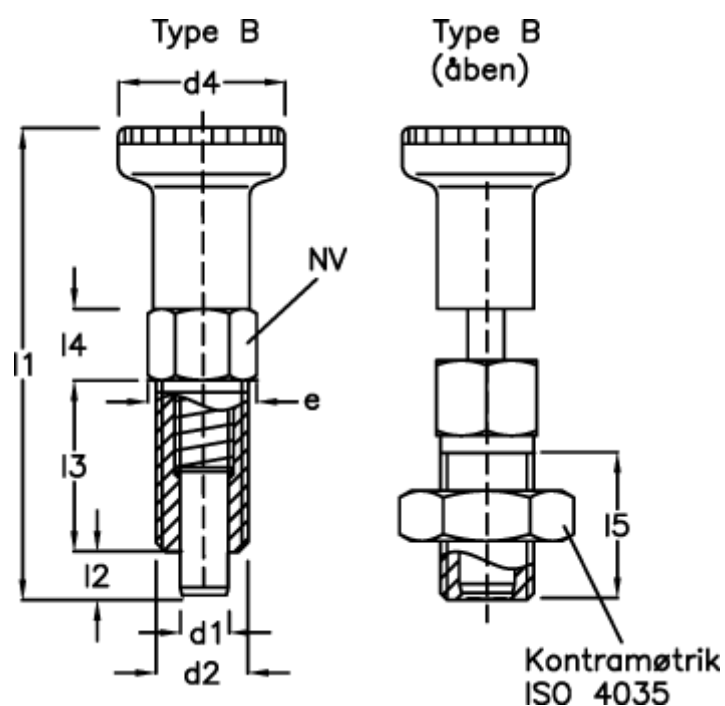

d1	= 4	l3	= 12
d2	= M6	l4	= 4.5
d4	= 12	l5	= 10.0
e	= 6.9	NV	= 6
Fjedertryk N bund	= 12		
Fjedertryk N top	= 3		
l1	= 30.5		
l2	= 4		